

产品规格承认书

SPECIFICATION FOR APPROVAL

客户名称:

CUSTOMER:

产品名称:

PRODUCT NAME:

方形保险丝

型号规格:

MODEL DETAIL:

AST T1A 250V

物料编码:

MATERIEL CODE.:

编制 PREPARED BY	审核 CHECKED BY	批准 APPROVED BY

承认 SIGNATURE	审核 CHECKED BY	批准 APPROVED BY

供方签章:

客户签章:

SUPPLIER:

CUSTOMER:

日期: 2017.9.22

日期:

DATE:

DATE:

备注: 承认签章后请回复一份承认书(或复印件)给我司, 其余由贵司留作存档。如果在签章的承认书(或复印件)回复给我司之前, 下了有关此零件的订单且又无特别说明, 那么我司就确定贵司已完全承认了。

Please return one specification or one copy of it with your chop and signature of approval and retain the others for your record. In the event of an order being placed for this part number before the chop and signed with specification (or copy) is returned and without special explanation, it will be assumed that full approval have been given.

	PRODUCT	EDITION NO.	A/0
	SPECIFICATION	FILE NO.	AL/A-013-08
	MODEL: AST	PAGE	PAGE 1 OF 5

1. 适用范围 Scope of application

本产品适用于各种电子机器内的电路中起过电流保护作用。

This product is suitable for various kinds of electronic machines to work for over current protection.

2. 相关标准及认证 Relevant Standards and Certification

2.1 执行标准 Standards: IEC60127-1 IEC60127-3 GB9364.1 GB9364.3

3. 结构及尺寸 Structure and Size (unit: mm)

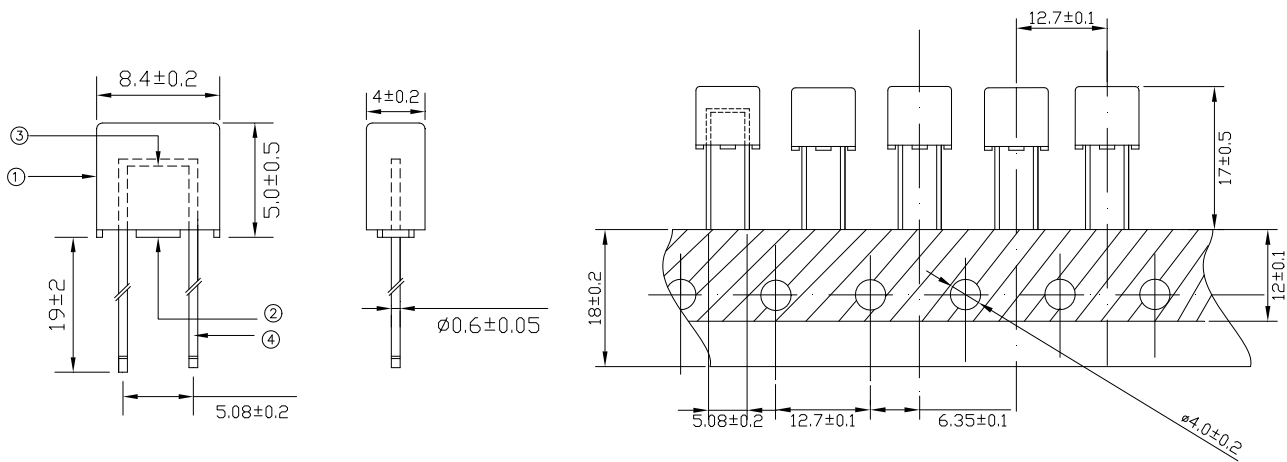

4. 原材料明细 Material Details

编号 No.	零件名称 Part Name	材质 Material
①	熔丝 Fuse element	合金线 Alloy
②	内芯 Core	尼龙 Thermoplastic Nylon
③	外壳 Case	尼龙 Thermoplastic Nylon
④	引线 Lead wire	镀锡铜线 Tinned copper wire

5. 标示 Marking

5.1 保险丝应有下列标示 The fuse shall have the following marking :

- 1) 延时符号 Time-lag Symbol: T
- 2) 额定电流 Ampere rating: 1A
- 3) 额定电压 Voltage rating: 250V
- 4) 认证符号 Approved Symbol UL

	PRODUCT	EDITION NO.	A/0
	SPECIFICATION	FILE NO.	AL/A-013-08
	MODEL: AST	PAGE	PAGE 2 OF 5

6. 外观 Appearance

6.1 外观不应有显著的污点、裂纹。

There shall not be any remarkable stain, rust or crack on the appearances.

6.2 标示应该很容易辨识。

Marking shall be easily legible.

7. 机械特性 Mechanical characteristics

7.1 拉力强度试验 Tensile test

将保险丝固定好后，对保险丝引线施加 5N 的拉力，持续 1 分钟。试验过后，保险丝没有任何破损现象。

Exert the axial pulling force of 5N to the both ends of lead wire for 1 minute. After the test the fuse shall be no damage and loosening.

7.2 推力试验(Thrust Test)

将保险丝保持在一个固定的位置，沿引线方向施加 2N 的推力，引线、方形塑料不能松动并且方形塑料不应破裂。

When fuse is fixed and the thrust 2N is applied in a direction to lead, no looseness of leads and square thermoplastic cap or damage of square thermoplastic cap shall occur.

8. 电气特性 Electrical characteristics

8.1 实验条件 Test condition

所有测试环境温度为 $25\pm 5^{\circ}\text{C}$ 。

All electrical characteristics tests are conducted at an ambient temperature of $25\pm 5^{\circ}\text{C}$.

8.2 分断能力 Interrupting rating test

保险丝能承受的分断能力：35A 或 10 倍的额定电流当中较大的。分断能力测试后测得保险丝的绝缘阻抗值大于 $0.1\text{M}\Omega$ 。

The fuse interrupting capacity: 35A or 10 times the rated current whichever is greater. After interrupting, the insulation resistance between the fuse terminations shall be not less than $0.1\text{M}\Omega$.

8.3 温度上升试验：通 1.5 倍额定电流 15 分钟，然后每隔 15 分钟增加 0.1 倍额定电流。测得保险丝断开时任何部位的温升不得超过 135°C ，周围环境温度为 $25\pm 5^{\circ}\text{C}$ 。

Temperature Rising Test: The rated current of 1.5 times is applied for 15 minutes. After the first 15minutes, the current is increased by 0.1 times the rated current every 15 minutes until the fuse operates. The temperature rising on the fuse surface is not higher than 135°C .

	PRODUCT	EDITION NO.	A/0
	SPECIFICATION	FILE NO.	AL/A-013-08
	MODEL: AST	PAGE	PAGE 3 OF 5

8.4 时间-电流特性 Time-Current Characteristics

额定电流的% % of ampere rating	熔断时间 Opening time
210%	2 min Max
275%	400 ms~10 s
400%	150 ms~3 s
1000%	20 ms~150 ms

8.5 耐久性测试 Endurance test

8.5.1 对保险丝通过相关标准规格单规定的额定电流 1 小时,然后截断电流 15 分钟,将该循环重复 100 次。试验过后保险丝没有任何破损现象。

A ampere rating specified in the relevant standard sheet is passed through the fuse for a period of 1h.The current is then switched off for a period of 15 minutes. This cycle is repeated 100 times. After the test the fuse shall be no damage and loosening.

8.5.2 然后对熔断体通以 1.5 倍额定电流 1 小时;并测量两端电压降,计算其最大功耗不能超过上表所规定的最大值。

Fuse through to 1.5 times the rated current of 1 hour; and measure the voltage drop across, to calculate the maximum power consumption can not exceed the above table under the maximum

8.5.3 测量熔断体两端的电压降,且电压降的增大量不大于试验前测得值的 10%。

Measuring both ends of the fuse voltage drop, and a large number of the increased voltage drop is not greater than 10% of the measured value before the test.

8.5.4 试验后,标记仍应清晰可辨,而且诸如端帽上的焊点不应出现任何明显的劣变。

After the test, the marking shall still be legible and soldered joints on end caps, for example, shall not show and appreciable deterioration.

8.6 焊接参数 Soldering parameters

8.6.1 波峰焊 260℃,最大10秒,

Wave soldering 260 °C,10 sec. Maximum

8.6.2 手工焊 370℃,最大5秒,

Manual soldering 370°C, 3 sec. Maximum

	PRODUCT	EDITION NO.	A/0
	SPECIFICATION	FILE NO.	AL/A-013-08
	MODEL: AST	PAGE	PAGE 4 OF 5

8.7 时间电流曲线图 Time- current curve

AVERAGE I-T CHARACTERISTICS CURVE
(FOR REFERENCE ONLY)
平均I-T曲线图(仅供参考)

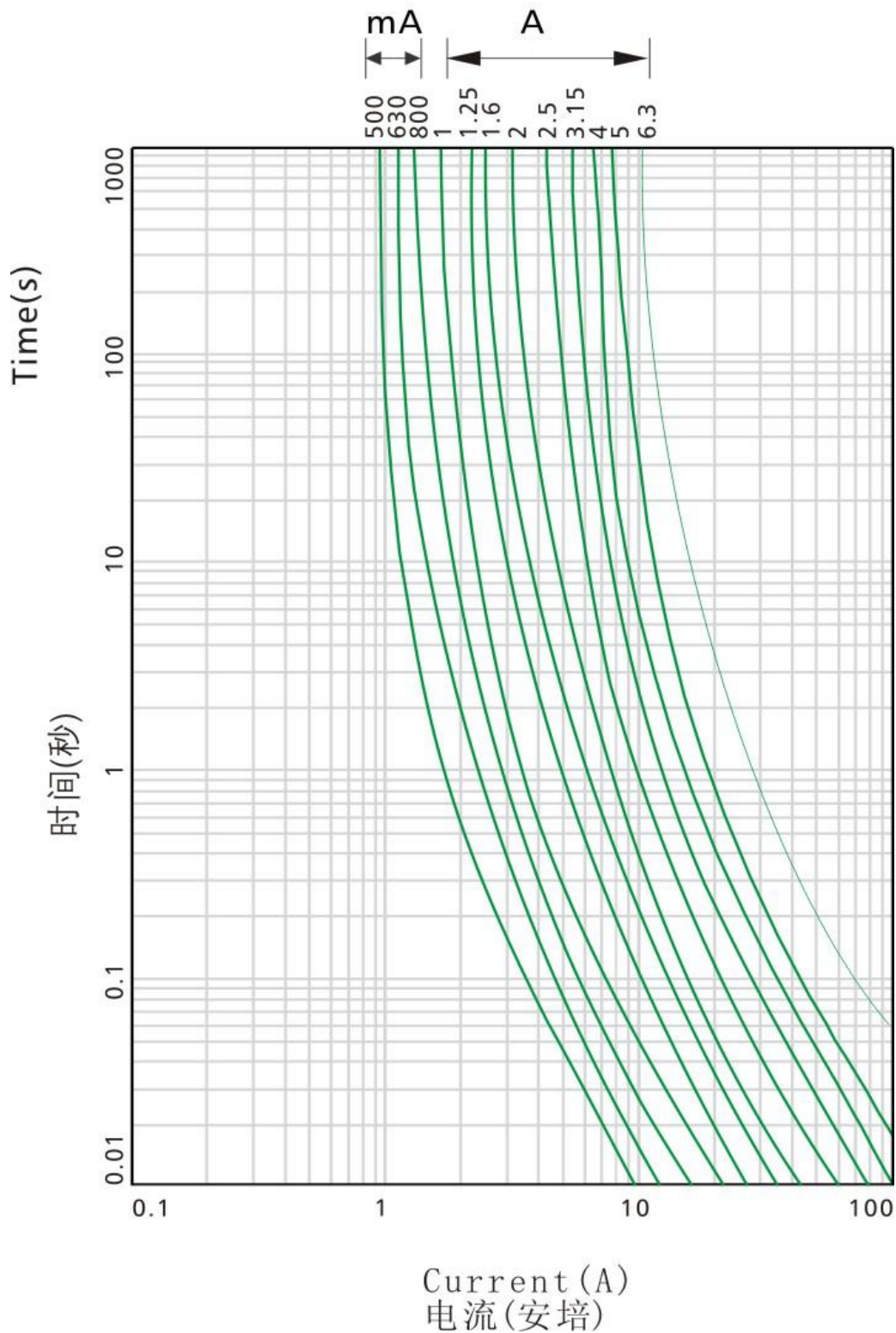

	PRODUCT	EDITION NO.	A/0
	SPECIFICATION	FILE NO.	AL/A-013-08
	MODEL: AST	PAGE	PAGE 5 OF 5

9. 环境特性 Environmental characteristics

9.1 使用温度范围 Operating Temperature

-55°C~125°C。

9.2 保存条件 Storage Conditions

相对湿度 \leq 75%，可存放3年。

Relative humidity \leq 75%, store 3 years .

10. 包装 Packing

10.1 包装方式：500PCS/小袋、3小袋/内盒、10内盒/外箱，自动机器编带1000PCS/内盒、10内盒/外箱(实际装箱依客户订单)。

纸盒规格：长 \times 宽 \times 高=180 \times 160 \times 80mm;

外箱规格：长 \times 宽 \times 高=425 \times 375 \times 180mm;

Packing Details:500 fuses per plastic bag, 3 plastic bags per inner box, 10 inner boxes per external carton. Automaton taped 1000 PCS per inner box, 10 inner boxes per external carton.(The actual case in accordance with the customer order)

Inner box dimension: Length \times Width \times Height=180 \times 160 \times 80mm

External carton dimension: Length \times Width \times Height=425 \times 375 \times 180mm

10.2 标签应包括：型号、额定电流、额定电压、额定分断电流、商标、安全标志、批量号码、公司标志、绿色的签章、RoHS & Pb-Free 标志。

The label in the smallest packing in which the fuses are put shall contain the Type, Rated Current, Rated Voltage, Interrupting Rating, Safety Approval Logo, Lot No., Trademark, seals in green, RoHS & Pb-Free mark.

10.3 产品的包装应能达到防潮、抗振的作用。以防在运输或贮存过程中产品受潮或受损坏。

Packing shall meet the requirements of anti-moisture and anti-shaking so that the products will not absorb moisture or be damaged during transportation or storage.